

Power Thermistor for Limiting Inrush Current (NTC Thermistor)

MF72-SCN10D-9

Features

- u RoHS & Halogen Free (HF) compliant
- u Body size: $\Phi 9\text{mm}$
- u Radial lead resin coated
- u High power rating
- u Wide resistance range
- u Cost effective
- u Operating temperature range: $-40\sim+200^{\circ}\text{C}$
- u Agency recognition: UL /cUL/RoHS



Recommended Applications

- u Switch mode power supply
- u Electric motor
- u Transformer
- u Adapter
- u Projector
- u Halogen lamp
- u LED driver circuit

Storage Conditions of Products

- u Storage Conditions:
Storage Temperature: $-10^{\circ}\text{C} \sim +40^{\circ}\text{C}$.
Relative Humidity: $\leq 75\%RH$.
Keep away from corrosive atmosphere and sunlight.
- u Period of Storage: 1 year.

Part Number Code

<u>MF72</u>	<u>SCN</u>	<u>10D</u>	-	<u>9</u>
(1)	(2)	(3)		(4)

- (1) MF72: MF72 Series.
- (2) SCN: Socay NTC.
- (3) 10D: Zero Power Resistance at 25°C (R_{25}): $10=10\Omega$.
- (4) Body Size: $9=\Phi 9\text{mm}$.

Power Thermistor for Limiting Inrush Current (NTC Thermistor)

MF72-SCN10D-9

Electrical Characteristics

Part Number	Resistance at 25°C ±20%	Max. Permissible Working Current	Resistance under Load (mΩ)	Dissipation Factor	Thermal Time Constant
	R ₂₅ (Ω)	I _{max} (A)	(mΩ)	δ(mW/°C)	τ(Sec.)
MF72-SCN10D-9	10	2	458	11	32

Maximum Power Rating (P_{max})

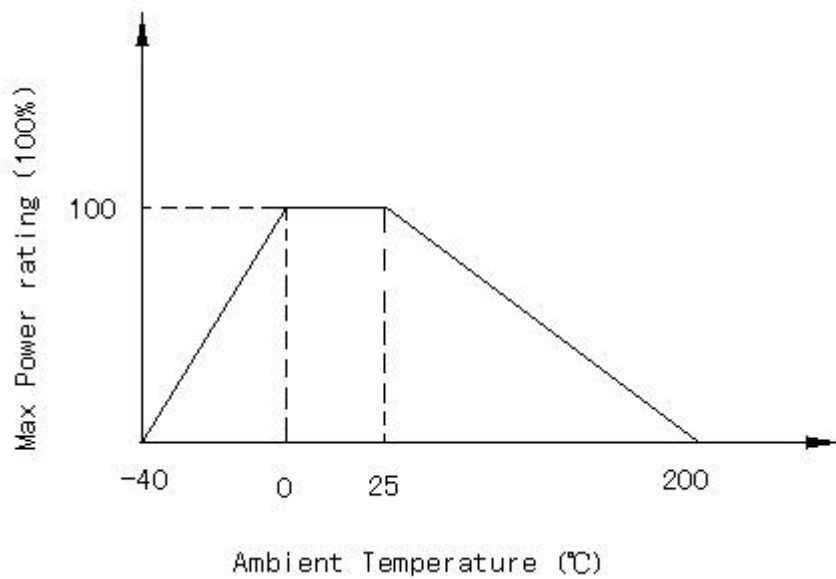

Power Thermistor for Limiting Inrush Current (NTC Thermistor)

MF72-SCN10D-9

Structure and Dimensions (Unit: mm)

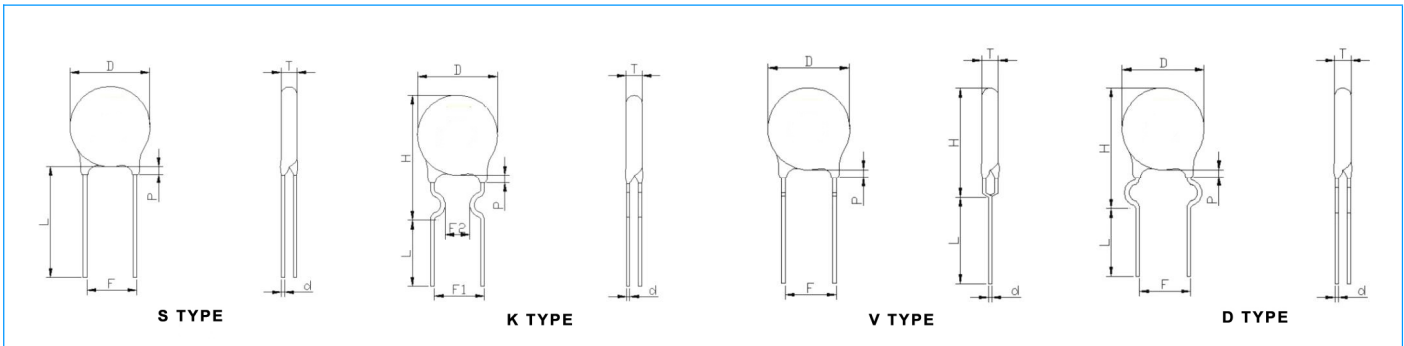

D max	T max	P max	F	H	L _{short} /L _{long}	d	Type
10.5	5.5	3.0	7.5±0.5	--	7±1/20±1	0.75	S
10.5	5.5	3.0	7.5±0.5	16.5±1	4±1/20±1	0.75	K/V/D

Note: Length of Pin (L) can be customized.

Packing Specification

Part Number	Type of L	Quantity (pcs/bag)
MF72-SCN10D-9	L _{short}	1000
	L _{long}	500

Reliability

Item	Test conditions / Methods	Test Result
Tensile Strength of Terminals	Fasten body with a Load Applied to each lead 3.0Kg for 1sec.	No break out and damage
Bending Strength of Terminals	Fixed body hand 1.0kg on one terminal bend 90 then back again oppsite.	No break out and damage
Solder Ability	When the Lead wire was dipped into bath of 235 ± 5 °C for 3 seconds after immersion in 25% rosin flux the solder ability ratio of lead wire surface should more than 95%.	More than 95% solder ability
Temp. Cycle Test	(-40°C×→+25°C×3min) × 5Cycles (-85°C×→+25°C×3min) × 5Cycles	ΔR/R ≤ ±20 %
Humidity Test	45°C 95%RH×1000 hours	ΔR/R ≤ ±20 %
Load Life	6 AMP×1000 hours	ΔR/R ≤ ±20 %
Insulation Test	DC 700V	R≥500MΩ